

User's Manual of Faratel UPS Smart Micro Series

Models:

■ SM1250BN

■ SM1250BN-RM

Read This First!

Faratel Message

Thank you for selecting this product of Faratel Company.

Entering the third millennium, Faratel with the idea of being pioneer of electronic industries, make effort to provide new products with up to date technology and try to support the satisfactory and necessity of its customers by improving the quality of products.

All Faratel's Departments are ready to receive any comment from customers by phone, fax or email.

Please Save This Manual!

It includes important instructions for the safe use of this UPS and for obtaining factory service should the proper operation of the UPS come into question. In that case please save it for future refers.

About this User Manual

While reading this manual you may face to some words as "Front Panel" or "Rear Panel". Please refer to Appendix 2 and 3 for the related figures.

Table of Contents	Page
1- Package Content	1
2- Introduction of Product	1
2-1- Advance Features	2
2-2- Protection Systems	2
3- UPSwing Family Software	3
4- Placement	4
5- Connections and installing the UPS	5
5-1- Rack-Mount Handles in SM1250BN-RM	5
5-2- RS232 interface Cable Connection (Optional).....	5
5-3- Telephone/LAN Cable Connection (Optional).....	5
5-4- Loads Connection	6
5-4-1- Estimating Power of Valid Loads	6
5-5- Earth and AC Line Connection	6
6- Controlling Operations	7
6-1- Power On UPS.....	7
6-2- UPS Test	8
6-3- Mute/Unmute Audible alarms during Power Failure	8
6-4- Power Off UPS.....	8
6-5- Controlling by UPSwing Pro Software	9
7- UPS Status Indicators	9
7-1- UPSwing Pro Event Messenger System.....	9
7-2- LED Indicators and Audible Alarms	10
8- Important Safety, Maintenance and Storage	12
9- Terms of Guarantee	13
10- How to Contact Faratel	14
10-1- Central Customer Service	14

Table of Contents	Page
10-2- Central Sales Department.....	14
Appendix 1: UPS Block Diagram.....	15
Appendix 2: Front Panel View	16
Appendix 3: Rear Panel View	17
Appendix 4: Technical Specification Table.....	18
Appendix 5: Faratel Software Products	19
Appendix 6: Checking Isolation between input and output	20
Appendix 7: Simple way for Calculating Ground Impedance	22

1- Package Content

- UPS System
- User's Manual
- CD-ROM of UPSwing Family Software
- RS232 Interface Cable
- Telephone Cable
- Earth Connection wire
- Rack-mount Handles and their screws in SM1250BN-RM
- Auxiliary Fuse
- Guarantee License
- List of Authorized Support Representatives in Iran

2- Introduction of Product

Faratel Smart Micro UPS series are designed with Line_Interactive technology and can provide pure sine wave in output independent from input AC line, also it can support consumer devices with appropriate and quasi-sine wave voltage in power failure.

It can protect computers and peripheral devices from utility line failures which may result in the loss or corruption of valuable data or make some hardware damages. In the event of a utility failure such as a blackout, brownout or sag, the UPS rapidly transfers loads (computer equipment) to an alternative power source which is derived from a battery within the UPS and provides the user with ample time to save files and properly close operations.

Faratel SM series are equipped with smart micro-processing system to check for proper operation of UPS and find probable errors in any part of the UPS.

SM UPS series are designed for Computer systems, Laboratory devices, Telecommunication or any other power sensitive devices.

Note:

Refer to Appendix 1 to check the Block Diagram of internal structure of UPS.

2-1- Advance Features

- Ability to remove EMI and RFI Noises
- System modulated for better and easy Servicing
- Low weight and size
- Equipped with Smart RS232 Port
- Includes UPSwing Pro software for controlling and monitoring UPS, auto saving open files and shutdown OS and UPS in critical events
- Contains Sealed Lead-Acid Batteries
- Includes Test Button for checking if UPS works properly in lack of AC line Voltage
- Intelligent microprocessor controlled
- Cold Start
- Automatically Battery Charging in UPS off mode
- In Rack-mount model (SM1250BN-RM)

2-2- Protection Systems

- Lightning, Spike and Surge Protection
- Back Feed Protection on Battery Mode
- Protection against two phased AC line
- Protection against output voltage variations out of range
- Protection against Input voltage and frequency variations
- Common Mode Noise protection
- Output short circuit and overload protection
- Protection against over-discharge
- Protection against upper battery charger voltage
- Tel/Fax/Modem/Network Surge Suppression

3- UPSwing Family Software

There is a CD-ROM in UPS Package which includes all UPSwing family softwares. After installing the UPS as following current user's manual, you can install the Single User version of UPSwing Pro Software free of charge.

Briefly, the Faratel UPS management Family Softwares have four main duties as below:

- 1- Auto Saving Mechanism: Auto saving applications and open files, downing OS(s) safely and power off the UPS in critical events as the end of backup time
- 2- Monitoring UPS: On-line Monitoring all main parameters and different status of AC line and UPS (locally or remotely)
- 3- Controlling UPS: Ability to sending on-line/scheduled commands to UPS to change the internal UPS settings (locally or remotely)
- 4- Event Messenger System: Uses so many tools as email, SNMP Traps, SMS and etc. for sending alarm or message in any different conditions of UPS and AC line also the ability of registering different events in text files and the facility of events commentary.

Note:

- Description of choosing appropriate software and the way of installing and using software is in PDF file named software user's manual that is available on CD-ROM.
- Installing all kinds of Faratel Softwares is considered as customers responsibilities.
- There is some more about the Faratel Family Softwares in Appendix 5.
- Refer to <http://www.faratel.com/software/> (Faratel Website) for more details about the UPSwing Power Management Software, downloading the latest version of software, sizing the network by Faratel Software or finding the User's Manual of the Software.

4- Placement

In order to place the UPS please pay attention to the following points:

- The UPS should be installed in protected environment. The location should provide adequate air flow around the unit, in an atmosphere free from excessive dust, corrosive fumes or conductive contaminants.
- Position the UPS to allow at least 10cm clearance with other devices. Keep the ventilation intake open.
- Do not operate the UPS in an environment where the ambient temperature or humidity is outside the limits given in the Appendix 4 (Technical Specification Table).
- UPS should be placed stand-up on an even surface. The Rack-mount models should be installed correctly inside the Rack.
- UPS connection cables should not be placed on passage.

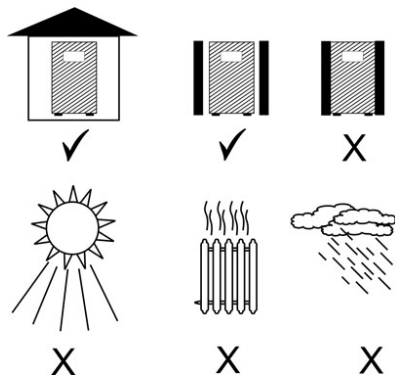

5- Connections and installing the UPS

5-1- Rack-Mount Handles in SM1250BN-RM

In RM series, as below figures, attach the handles to metal plate ("L" shaped) then to the device with screw, finally fix it to the Rack.

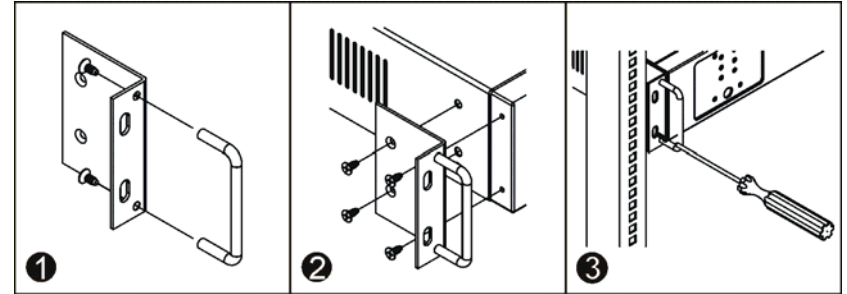

5-2- RS232 interface Cable Connection (Optional)

- In order to use the advantages of UPSwing Pro Family Softwares you need to connect the Serial Cable to Computer.
- Please turn off computer and UPS before connecting the cable to them, then connect the Male side to UPS and the Female side to one of the Computer COM Ports.
- Although the UPS do its own duty without using UPSwing Pro but it is recommended.

5-3- Telephone/LAN Cable Connection (Optional)

In order to have surge protection for your Telephone, Modem, LAN or any other devices, connect the data line to INPUT RJ45/11 socket (on rear panel) and by using another data cable connect your device to OUTPUT RJ45/11 socket. A telephone cable is contained in UPS package to use for connecting the Telephone, Modem and etc. to OUPUT socket.

5-4- Loads Connection

- Before connecting any load except Computers please call Faratel Authorized Customer Services for avoiding any problem with UPS or the loads.
- On the rear panel of UPS some output receptacles are placed, that white receptacles use for load connection and black one is surge suppressor that used for connecting laser printer or plotter, notice that the black receptacle has no output while power failure, So for supporting computer equipments in power failure connect their plugs to the white output Receptacles. Don't plug the printer to the white output receptacles.
- Attention that connected loads just obtain their earth connection from UPS and do not have any other patch to the earth. Also for earth system bonding it is recommended to use the earth screw on the rear panel in rack mount models and under UPS in stand up models
- It is recommended to use just 70% of UPS nominal power.

5-4-1- Estimating Power of Valid Loads

Follow as below to estimate the total power of loads and check if it is possible for UPS or not.

- 1- Make the list of loads.
- 2- Computer equipment manufacturers must provide a load rating for their products. Usually, the rating is written on a name plate or label nears the line cord in VA. If there is not, read the Current in Ampere (A) and the Voltage in Volts (V) and multiply them to find out the Power of each load in VA.
- 3- Sum all the VA values to find out the total power of loads. The result value should not be more than UPS nominal power. As mentioned before it is recommended to use 70% of UPS nominal power.

5-5- Earth and AC Line Connection

- Please make sure that the receptacles and connection wire are grounded.

- There shouldn't be any connection between input and output wiring of UPS. It means wiring should not use Neutral sharing. For checking the correct wiring, refer to Appendix 6.
- After AC line connected, if SWF (Site Wiring Fault) LED indicator on rear panel turns on, first check if the input Line (Phase) and Neutral is not reversed. If the indicating continued the problem should be caused by high Neutral-Earth voltage. In this matter customer must be certain about the rectitude of Earthing system. In order to calculate the Earth Impedance refer to Appendix 7. Another reason of this high voltage is because of unbalanced loads in 3-phase system which generates a high Neutral current.
- For earth system bonding it is recommended to use special earth connection screw on the rear panel in rack mount models and under UPS in stand up models. In this case even if you get the plug out from outlet, the connection of earth system will be available. Pay attention that earth wire of receptacles and earth wire connected to the screw both coming from the same place and there isn't voltage difference between them.
- The earth hole must be built upon Iranian Construction Engineering instructions. Standard earth connection is necessary for safety of users and protection against common mode noises. If there is not appropriate earth hole, just for reducing common mode noises you can use the connection of UPS frame case to the metal frame of building or metal water pipe.
- connect input plug to the wall outlet.

6- Controlling Operations

6-1- Power On UPS

- After choosing the best place for installing the UPS, according to current user's manual, it is the time for power on and using the UPS.
- If this is the first time for power on the UPS, please charge the batteries for 10 hours. In order to charging, just connect the UPS to AC line. It means UPS

charger do its job even the UPS is in Power off and the AC line is connected to UPS.

- In order to power on the UPS press Power button on front panel until audible alarm ends. If the input voltage and frequency are in normal range, UPS powers on AC otherwise UPS uses batteries for output and powers on in Battery mode.

6-2- UPS Test

- The Test function allows you to check for proper operation by initiating a transfer to on-battery operation. This test ensures that UPS will support the system load during an actual power disturbance. By using the Test function throughout the life of the UPS, you can estimate when the UPS's battery should be replaced.
- By pushing Test button for a moment from front panel of UPS the test function starts. After the process, by LED indicators which are displayed in "LED Indicators and Audible Alarms" or using advance tools in UPSwing Pro Software you can check if the Batteries are OK or needed to replace or charge them.

6-3- Mute/Unmute Audible alarms during Power Failure

While UPS is supplying output provided by Battery (Battery Mode), the UPS internal audible alarm is beeping. In this Mode by pressing "Power/Test" button (Placed on front panel) for more than 1 second, the sound alarm will disabled or enabled.

6-4- Power Off UPS

UPS can be turn off in two steps:

- 1- By pressing "Power" button on front panel for 3 seconds, UPS will turn off. In this case Internal UPS charger circuits are in order to charge the batteries.
- 2- In order to completely power off the UPS, after the above step, plug out UPS from outlet.

6-5- Controlling by UPSwing Pro Software

By installing UPSwing Pro Software and depends on Firmware version of UPS you will achieve to send some commands or change some settings of UPS which are listed in below:

- Ability to send Shutdown command in Power Fail Mode to save Battery charge. UPS will automatically power on when the AC Line become normal.
- Ability to Test UPS manually or by schedule (Daily, weekly, monthly and etc.)
- Ability to set the UPS work time by scheduling the Sleep and Wake up time weekly or by date
- Ability to mute or unmute the UPS sound alarms as Power Fail, Site Wiring Fault and etc.
- Ability to send restart command for restarting the Computers and UPS
- Ability to adjust delay time for shutting down UPS after sending sleep or shut down commands, depends on unknown shut down time of computer systems.

7- UPS Status Indicators

There are 2 ways for getting the UPS operating status:

- 1- By using UPSwing Pro Software
- 2- By LED indicators in front/rear panel of UPS, audible alarms or combination of them

7-1- UPSwing Pro Event Messenger System

- By installing UPSwing Pro you can monitor all statuses of UPS and AC line locally or via network. Some parameters of monitoring are mentioned such as: Input/output Voltage, Load Level, Battery Level, Input/Output Frequency, UPS Model, UPS Nominal Power and etc.
- Also UPSwing Pro notices some events and statuses such as: On Battery, Site Wiring Fault, Standby, Over Heat, Fault, Overload, Normal, Buck/Boost Mode,

Bad V Out, High Bat, Battery Defect, Enable/Disable Audible Alert, Low/Weak Battery, Low/High Voltage, Power Fail and etc.

- UPSwing Pro equipped with a great Event Messenger system which contains some strong tools. By these tools the user can receive the message of any event status in different ways which are described below:





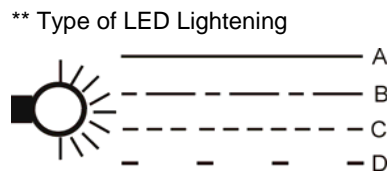
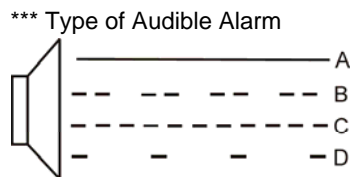

- Ability to pop up a message in corner of monitor screen or by pop up a new page when you are monitoring the UPS via web in order to notice the events
- Ability to play user defined wave files in any different conditions
- Ability to send messages via pager
- Ability to dial up and send voice message of any events
- Ability to execute user defined files in each condition of UPS.
- Ability to send Fax of the latest events by UPSwing Telephony
- Ability to send emails, SNMP Traps and SMS in all different events

7-2- LED Indicators and Audible Alarms

UPS indicates operating status using a combination of visual and audible indicators.

The following table describes the different statuses and events. The numbers in column "*" define the place of the LED indicator in figures which are in Appendix 2 (Front Panel View) or Appendix 3 (Rear Panel View). Also the columns "***" and "****" can understand from the following figure which shows the type of LED lighting and audible alarm.



*	Visual Indicators		*** Audible Indicators		Status/Event Description	
	Name	**Lightning				
2 	Boost	On	A		Input Voltage is low so UPS do the action of filtering and amplification	
		Flashing	C	Beeping	D	Input Voltage is low and out of range so the UPS is supplying output provided by the AC Line via inverter
3 	Normal	On	A		Suitable input voltage	
4 	Buck	On	A		Input Voltage is high so UPS do the action of filtering and reduction	
		Flashing	C	Beeping	D	Input Voltage is high and out of range so the UPS is supplying output provided by the AC Line via inverter
5 	Backup	Flashing	D	Beeping	D	UPS has been supported by Battery and while finishing its charge, flashing and beeping faster.
	Testing		B		B	UPS has been testing its batteries
6 	Battery Defect	On	A		Test result: Battery is too low or spoiled	Charge batteries for at least 10 hours
		Flashing	D		UPS has been supported by Battery, and the battery is found spoiled or too low so UPS has been disconnected the output	
			C	Beeping	C	UPS is in trouble so call Faratel Authorized Customer Services
7 	Overload	On	A	On	A	UPS will turn off after 1 Minute when nominal power is 110%~130% or 3 seconds when nominal power is more then 130%.
	Sleep	Flashing around	C			The UPS has slept by UPSwing Pro software and will wake up manually or by scheduled settings.
4 (Rear Panel)	Site Wiring Fault	On	A			The Neutral-Earth Voltage is not proper for UPS. For debugging reverse the plug otherwise check the ground.

© All Front Panel LEDs

8- Important Safety, Maintenance and Storage

- During the environment where the ambient temperature is -15°C to $+30^{\circ}\text{C}$, charge the UPS's battery every 6 months and it reduces to 3 months in $+30^{\circ}\text{C}$ to $+45^{\circ}\text{C}$.
- Check isolation of input and output connection cables monthly.
- Do not dispose of Batteries in a fire
- Hazardous live parts inside the UPS are energized from the battery supply even when the input AC power is disconnected. In that cases, the risk of electric shock is existing so do not remove cover of UPS.
- Do not open or mutilate the Battery, released electrolyte is harmful to skin and eyes.
- Keep the UPS clean, uncover and vacuum the ventilation intake periodically and wipe UPS with soft loose and damp cloth.
- Do not stack material and liquids on the UPS.

9- Terms of Guarantee

Faratel guarantees the operation and quality of its UPS for one year. In order to use Faratel Customer Services, Guarantee License (which included in UPS package) should fill by Faratel representative and post Customer Service section to Faratel. If any trouble occur while UPS operating, first take a note of model and serial number of UPS then contact with nearest Faratel representatives.

These instances are out of guarantee:

- Non-observance the points which are in user's manual and Guarantee License
- Non-observance of correct wiring or earth connection
- Opening the cover of case or repairing the UPS by not authorized representatives
- Not filling or not sending the Guarantee License (contains in UPS package) to Faratel Central Customer Support Service after 1 month of buying
- Any damages as a result of wrong operation, dropping from height, crash, heat to other things, fire, earthquake or being in touch with water or acid and any other similar things
- Not installing or using the batteries inside the UPS after 6 months

10- How to Contact Faratel

10-1- Central Customer Service

Address: Faratel, Shahid Abdolrahimi St., 17 Shahrivar St., Sanay-e Felezi St., Fifth Kilometer of Old Karaj Rd., Tehran, Iran
 Postal Code: 1378763511
 Telephone: (+98 21) 6680 9495 up to 7
 Fax: (+98 21) 6680 5525
 Email: support@faratel.com
 URL: <http://www.faratel.com/support/>

In order to find the nearest authorized representatives of Customer Service in Iran please refer to the above URL or the list which is included in UPS package.

10-2- Central Sales Department

Address: Faratel Bldg., No. 12, Kandovan Alley (Opposite of Nejatolahi St.), Enqelab St., Tehran, Iran
 Postal Code: 1131834914
 Telephone: (+98 21) 6670 0001 up to 5
 Fax: (+98 21) 6670 9493
 Email: sales@faratel.com
 URL: <http://www.faratel.com/support/>

Appendix 1: UPS Block Diagram

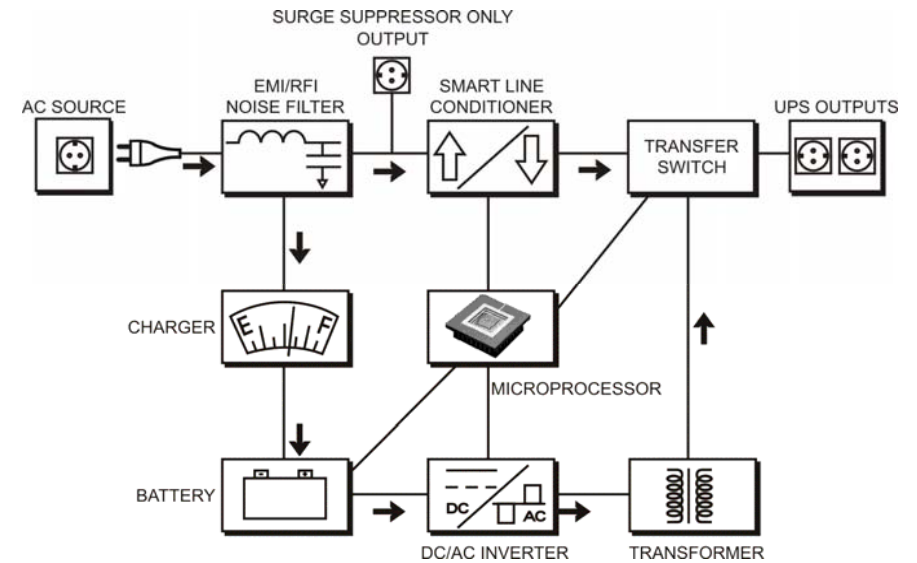

Figure 1: Block Diagram of SM Series

Appendix 2: Front Panel View

The meaning of each indicator or operations of the buttons are described in this User's Manual especially in "UPS Status Indicators" and "Controlling Operations".

- | | |
|--------------------------|-----------------------------|
| 1- Power/Test Button | 5- Backup Mode Indicator |
| 2- Boost Indicator | 6- Battery Defect Indicator |
| 3- Normal Mode Indicator | 7- Overload Indicator |
| 4- Buck Indicator | |

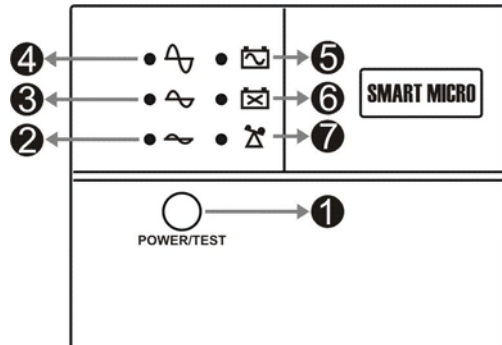

Figure 1: Front Panel of SM1250BN

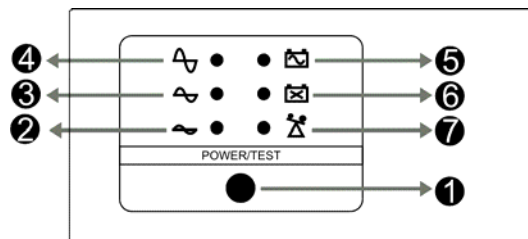

Figure 2: Front Panel of SM1250BN-RM

Appendix 3: Rear Panel View

- 1- Input AC Line Cable
- 2- Input Fuse
- 3- Earth Connection Screw
- 4- Site Wiring Fault Indicator
- 5- Grounded Output Receptacles
- 6- Surge Suppressor grounded Output Receptacles
- 7- Smart RS232 Port
- 8- Modem/Network Surge Protection

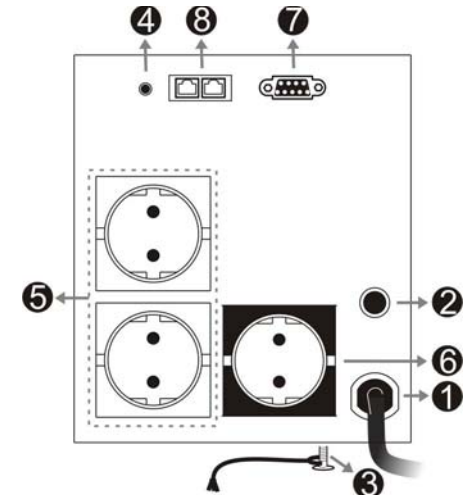

Figure 1: Rear Panel of SM1250BN

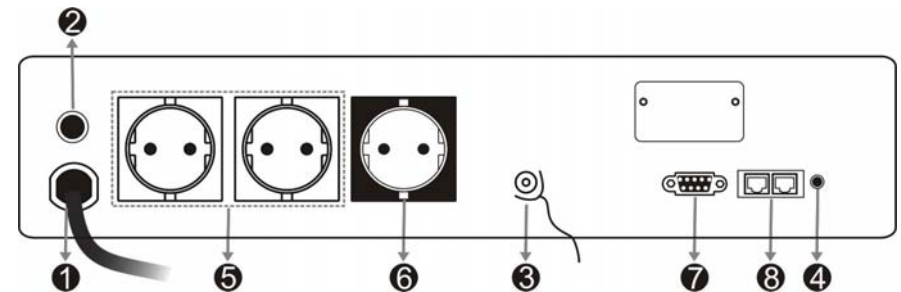

Figure 2: Rear Panel of SM1250BN-RM

Appendix 4: Technical Specification Table

Model		SM1250BN	SM1250BN-RM
Technology		Line-Interactive	
Power		1250VA - 750Watt	
Input	Voltage	220VAC±20%	
	Max. Current	10A	
	Frequency	50Hz±5%	
	Phase	Single Phase	
	Nominal Power Factor	0.6	
Output	Voltage	AC Mode: 220 VAC±10% Sine Wave Battery Mode: 220Vr.m.s±5% Quasi-Sine Wave	
	Current	5.68A	
	Frequency	AC Mode: 50Hz±5% Battery Mode: 50Hz±0.2%	
	Phase	Single Phase	
	Nominal Power Factor	0.6	
	Over Load Capacity	110%~130% of Nominal Power for 1 Minute More than 130% of Nominal Power for 3 Seconds	
Battery	Type	Sealed Lead Acid Batteries with Free Maintenance	
	Voltage	24VDC	
	Internal Battery	2*(12V/7Ah)	
	Recharge time	10 hours after 90% discharge	
	External Battery	Not Available	
Efficiency		>75% in Normal Mode	
Transfer time		2.5msec	
Physical Specification	Dimension(H*D*W) (mm)	140*385*169	With Handles: 483*387*90 Without Handels: 457*357*90
	Shipping Weight (Kg)	15	17.8
	Net Weight (Kg)	13.6	16.3
Environment	Ambient Operation	Temperature	0 ~ 40°C
		Humidity	0 ~ 95% humidity (non-condensing)
		Height	1000 meters max. elevation (Based on IEC62040)

Appendix 5: Faratel Software Products

Faratel has designed UPSwing Family Softwares for Monitoring and Controlling the UPS locally or remotely. The below table shows the Faratel software products are divided into two main groups.

Software		Summary of Usage
UPSwing Pro/Plus	Single User	This software is designed for Windows OS to monitoring and controlling the local UPS via RS232 connection. This software is free of charge and every one can download the latest version from Faratel website for installing and using.
	Network Support	This Software is designed for monitoring and controlling the local and remote UPSs. This Software supports HTTP and TCP/IP protocols for having the remote managing. Also this software can make connection to UPSwing Netshut. In order to install and using this Software you need to buy License Cards from Faratel Sales Department.
UPSwing Netshut		This software installs for client PCs or other Servers to make communication with UPSwing Pro Family Software to receive Shutdown commands in any critical events of UPS. UPSwing Netshut will save the open files automatically, close applications and down the OS normally after receiving the Shutdown commands. In order to install and using this software you need to buy a License Card (for each Client) from Faratel Sales Dept.

All above Softwares support the following Operating Systems:

Windows, Linux, SCO UNIX, SCO UNIX Ware, FreeBSD, Sun Solaris, OS/2, Novell, HP-UNIX

Note:

Please refer to <http://software.faratel.com> for more information.

Appendix 6: Checking Isolation between input and output

- Purpose:

In order to use and operate the UPS, input and output wiring must be isolated. For confidence, do the below test and check if the input line and neutral is completely isolated from output line and neutral.

- Required tools for testing:

1- One Lamp with its holder

Note: Use two serried lamps if there is a case of two or three phase in wiring.

2- Electrical wires for connections

-Test recipe and results:

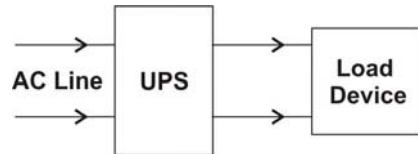

According to above figure, UPS is installed between AC Line and load device. By using lamp instead of UPS in different case (6 cases) as the following figure we expect that the Lamp lights on just in one case. Just by this way we become sure about the input and output isolation.

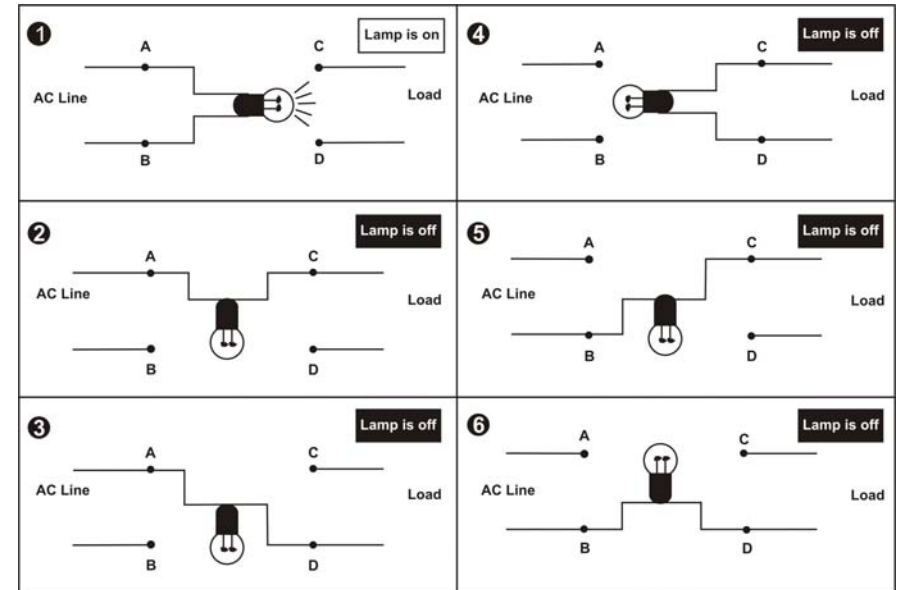

Appendix 7: Simple way for Calculating Ground Impedance

- Purpose:

A good ground system is required for installing and using the UPS. Therefore, the below test will show how to calculate the ground impedance and finding if it has a good status or not.

- Required tools for testing:

- 1- One 100Watt Lamp with its holder
- 2- One Voltmeter
- 3- ON/OFF Key
- 4- Electrical wires for connections

-Test recipe

- 1- Connect lamp, volt meter and key as following circuit to line and neutral.

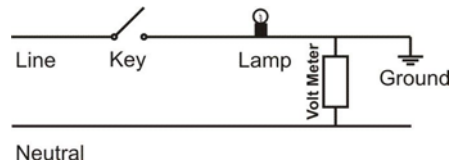

- 2- Turn the Key to OFF mode (lamp is off) and read the AC voltage from voltmeter and set it to V1.
- 3- Turn the key to ON mode (lamp is on) and read the AC voltage and set it to V2.

- Calculating:

- 1- The Current of 100Watt lamp in ampere calculate as below formula.

$$I_{Lamp} = \frac{P}{V} = \frac{100W}{220V} = 0.4545 \quad (1)$$

- 2- Now calculate the impedance (R) between ground and neutral from below formula in OHM.

$$R = \frac{\Delta V}{I} = \frac{V2 - V1}{I_{Lamp}} = \frac{V2 - V1}{0.4545} \quad (2)$$

- Result:

- 1- The ground system would be more appropriate whenever the value of R which calculated from equation 2 become lower.
- 2- The safety of ground system will be determined according to load and device technical specification
- 3- Whenever the calculated impedance is less than 2Ω , the ground system status is fine.